

NCE H.F Energy saving circulating pumps with flanges



Construction

Energy saving variable speed circulating pump driven by a permanent magnet synchronous motor (pm) controlled by on board inverter.

Applications

Heating and conditioning systems.

Operating conditions

- Liquid temperature from +2 °C to +110 °C
- Ambient temperature from 0 °C to +40 °C
- Maximum permissible working pressure: 10 bar
- Storage: -20°C/+70°C max. relative humidity 95% at 40 °C
- Certifications: in conformity with CE requirements
- Sound pressure \leq 40 dB (A).
- Minimum suction pressure: - 0,05 bar at 75 °C
- 0,28 bar a 90 °C.
- Maximum glycol quantity: 20%.
- EMC according to: EN 55014-1, EN 55014-2
EN 61000-3-2, EN 61000-3-2.
- Connections: Flanges according to PN 6/10, EN 1092-2, DN 32, 40, 50.
- The benchmark for most efficient circulators is $EEI \leq 0,20$.

Designation

NCE H 32 F - 60 / 220

Series _____
 Version _____
 DN ports in mm _____
 With flanges _____
 Max. head in dm _____
 connection size mm _____

Motor

- Synchronous motor with permanent magnet.
- Motor: variable speed
 - Standard voltage: single-phase 230 V (-10%;+6%)
 - Frequency: 50-60 Hz
 - Protection: IP 44
 - Insulation class: F
 - Overload protection (integrated).
 - Cable: phases and neutral.
 - Constructed in accordance with: EN 60335-1, EN 60335-2-51.

Special features on request

- Additional module:
- analog input 0-10V
 - remote on/off input
 - output relay

Features

Smart pump

NCE H.F adapt its functions to the system: the circulator measures the pressure and the flow and adjusts the speed to the selected pressure.

Easy use

There are different operating modes selectable from the control panel.

Operating modes



Automatic mode

(factory setting):

In this mode the pump automatically sets the operating pressure, depending on the hydraulic system. This mode is recommended in most systems.



Proportional pressure mode:

The circulator changes the pressure proportionally to the current flow. The pressure value can be adjusted with the + and - buttons.



Constant pressure mode:

The circulator maintains the pressure constant when the reference flow changes. The pressure value can be adjusted with the + and - buttons.



Fixed speed mode:

The circulator works with constant curve and the curve could be changed using + e - buttons.



Night mode:

When the liquid temperature fall by 15-20°C the pump automatically swiches to night mode, in practice the circulator works at minimum curve. When the temperature rises again the pump comes back to the selected mode. The night mode could be selected with any operating mode.

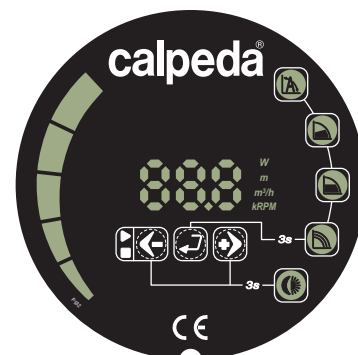

Operating mode-control panel

NCE H.F could works in:

- automatic mode
- proportional pressure mode
- constant pressure mode
- fixed speed mode
- night mode

The night mode could be selected with any operating mode.

Coverage chart

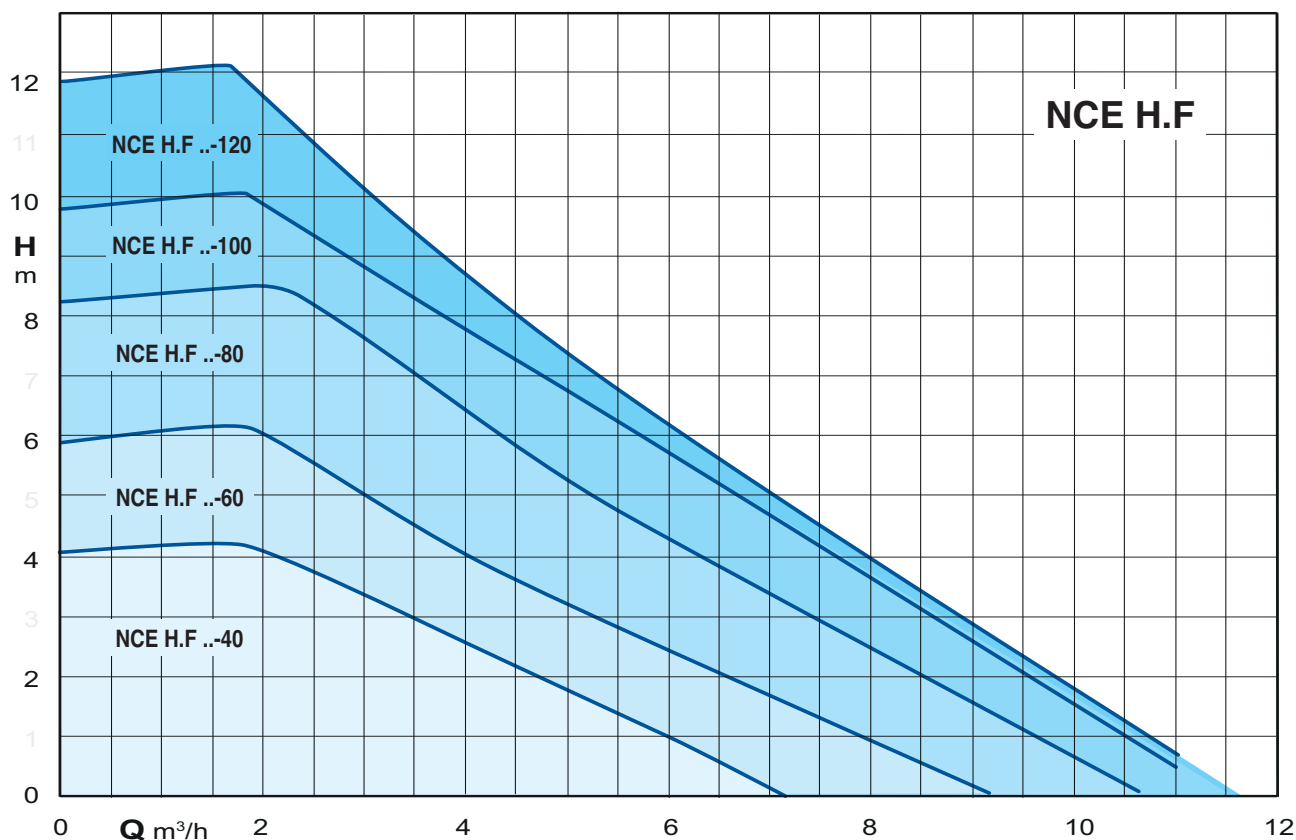

Characteristic curves

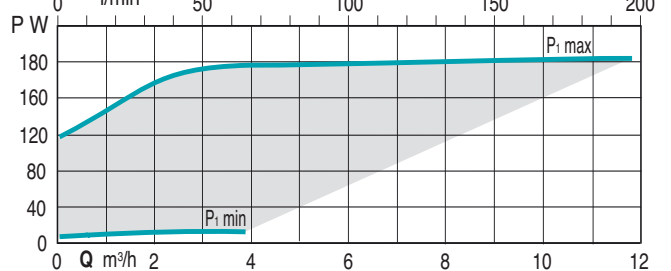
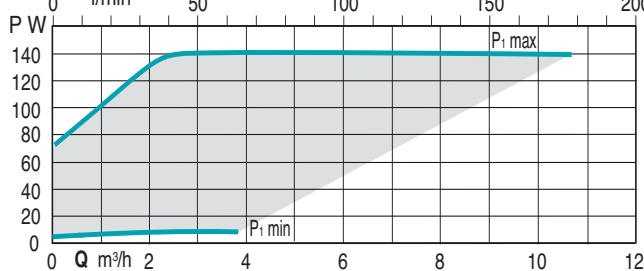
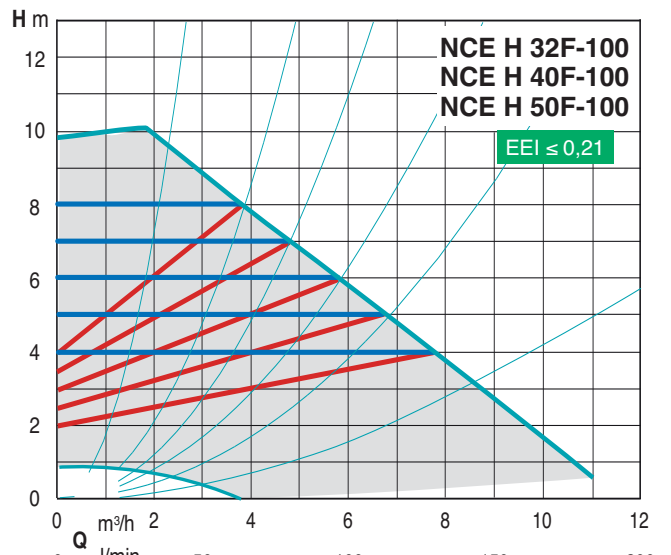
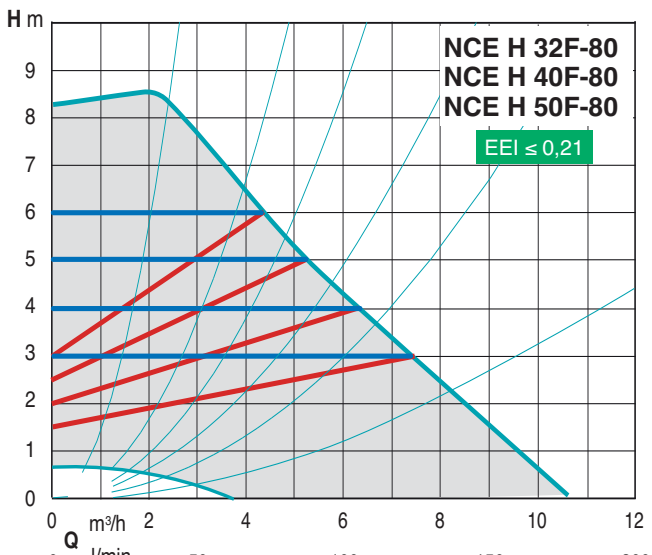
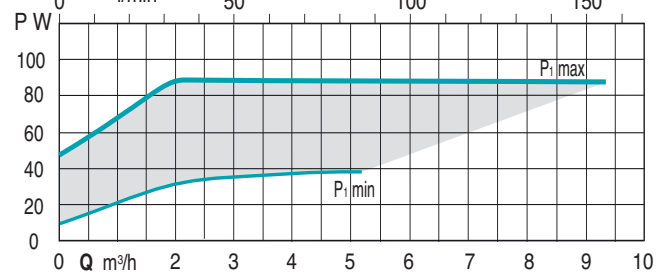
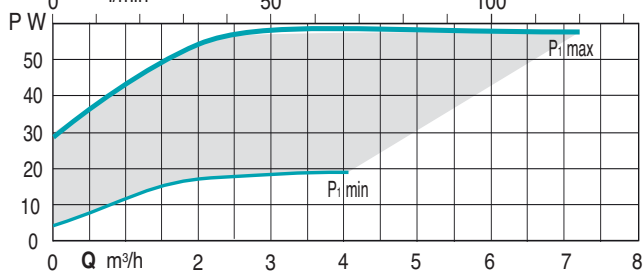
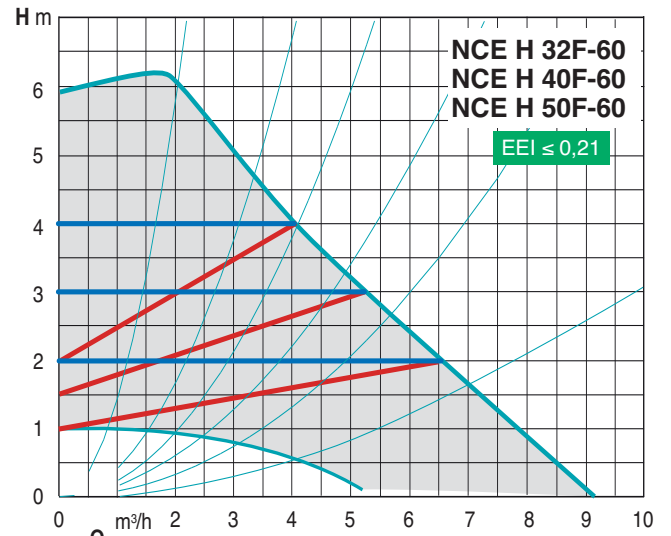
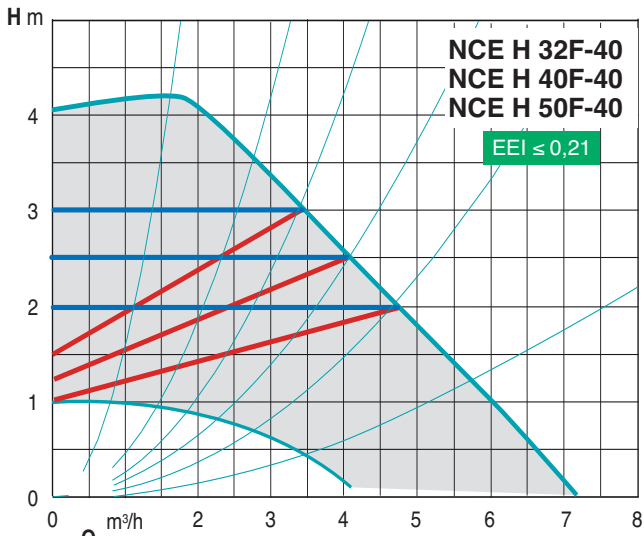

Characteristic curves

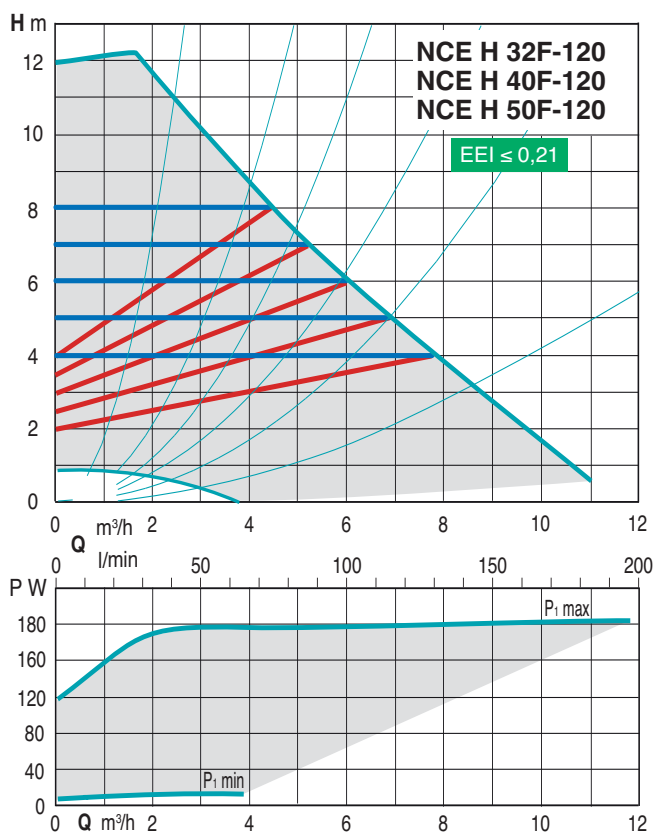

Materials

Component	Pos.	Material
Pump casing	1	Cast iron GJL 200 EN 1561
Impeller	2	Composite
Shaft	3	Stainless steel
Bearings	4	Carbon
Thrust bearing	5	Ceramic
Rotor	6	Stainless steel jacket
Winding	7	Copper wire
Electronic card	8	-
Gasket	9	EPDM

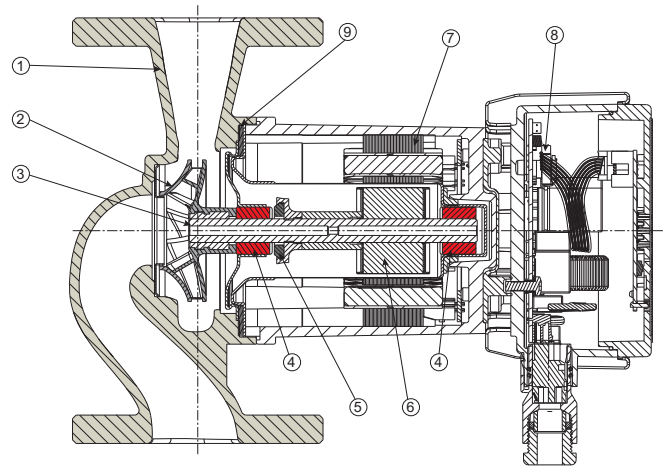

Examples of installations

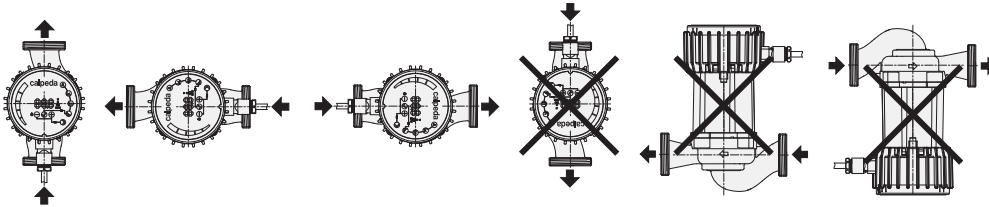

Dimensions and weights

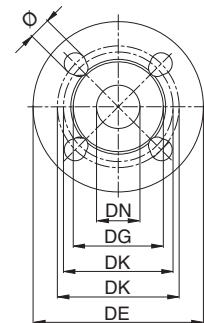
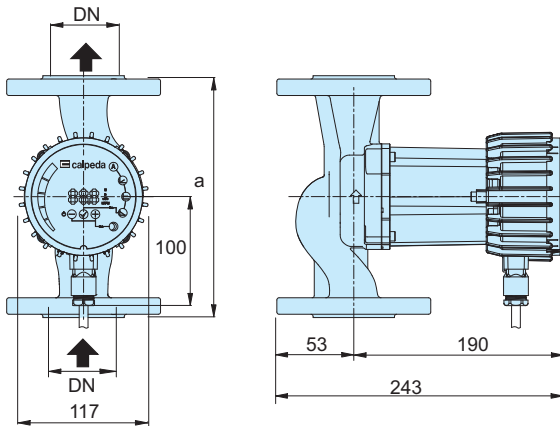

TYPE	DN	H m	Q m ³ /h	1~ 230 V		P ₁		a mm	kg
				A min	A max	W min	W max		
NCE H 32F-40/220	32	4	5	0,1	0,5	10	60	220	7,4
NCE H 40F-40/220	40							220	8,5
NCE H 50F-40/240	50							240	9,8
NCE H 32F-60/220	32	5	7,5	0,1	0,75	10	90	220	7,4
NCE H 40F-60/220	40							220	8,5
NCE H 50F-60/240	50							240	9,8
NCE H 32F-80/220	32	8	9	0,1	1,15	10	140	220	7,4
NCE H 40F-80/220	40							220	8,5
NCE H 50F-80/240	50							240	9,8
NCE H 32F-100/220	32	10	11	0,1	1,5	10	180	220	7,4
NCE H 40F-100/220	40							220	8,5
NCE H 50F-100/240	50							240	9,8
NCE H 32F-120/220	32	12	15	0,1	1,5	10	180	220	7,9
NCE H 40F-120/220	40							220	8,7
NCE H 50F-120/240	50							240	10

DN	DE	DK	DG	holes	
				N.	Ø
32	140	90/100	74	4	14/19
40	150	100/110	80	4	14/19
50	165	110/125	90	4	14/19