



NMT SMART C 32/80-180

979527146

NMT SMART C / Electronically regulated circulating pump - communication

GENERAL

Part number	979527146		
Part name	NMT SMART C 32/80-180		
Seal type		EEl	0.21
Net weight	3.85 [kg]		
H max	8.4 [m]	H min	0.0 [m]
Q max	12.3 [m3/h]	Q min	0.0 [m3/h]
	[%]		
Noise	≤43 dB(A)		

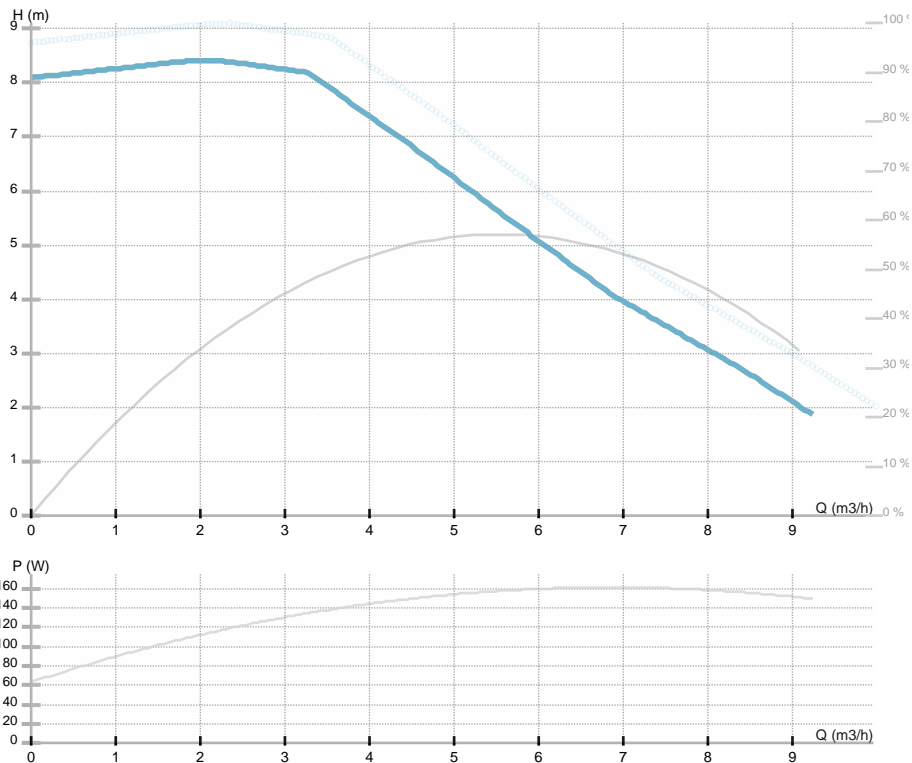

ELECTRICAL DATA

Power supply	1~230 V
Mains frequency	50/60 Hz
Motor power	150 [w]
RPM	3900 [1/min]
Insulation class	F
Declared current	1.3 [A]
Declared protection	IP44
Thermal protection	NTC
Frame size	
Motor IE class	

INSTALLATION

Fluid	Water VDI 2035, glycol 40%
Fluid temperature	-10.0 ÷ 110.0 [°C]
Ambient temp.range	40 deg C
Length	180 [mm]
DN	32 [mm]
Connector	G 2
Connection	G 2
Max pressure	1.0 MPa

MATERIAL

Bearing material	Graphite
Impeller material	PES GF 30
Hydraulics material	Gray cast iron
Shaft material	AISI 420

NMT SMART C 32/80-180

979527146

NMT SMART C / Electronically regulated circulating pump - communication





NMT SMART C 32/80-180

979527146

NMT SMART C / Electronically regulated circulating pump -
communication

Dimension drawing

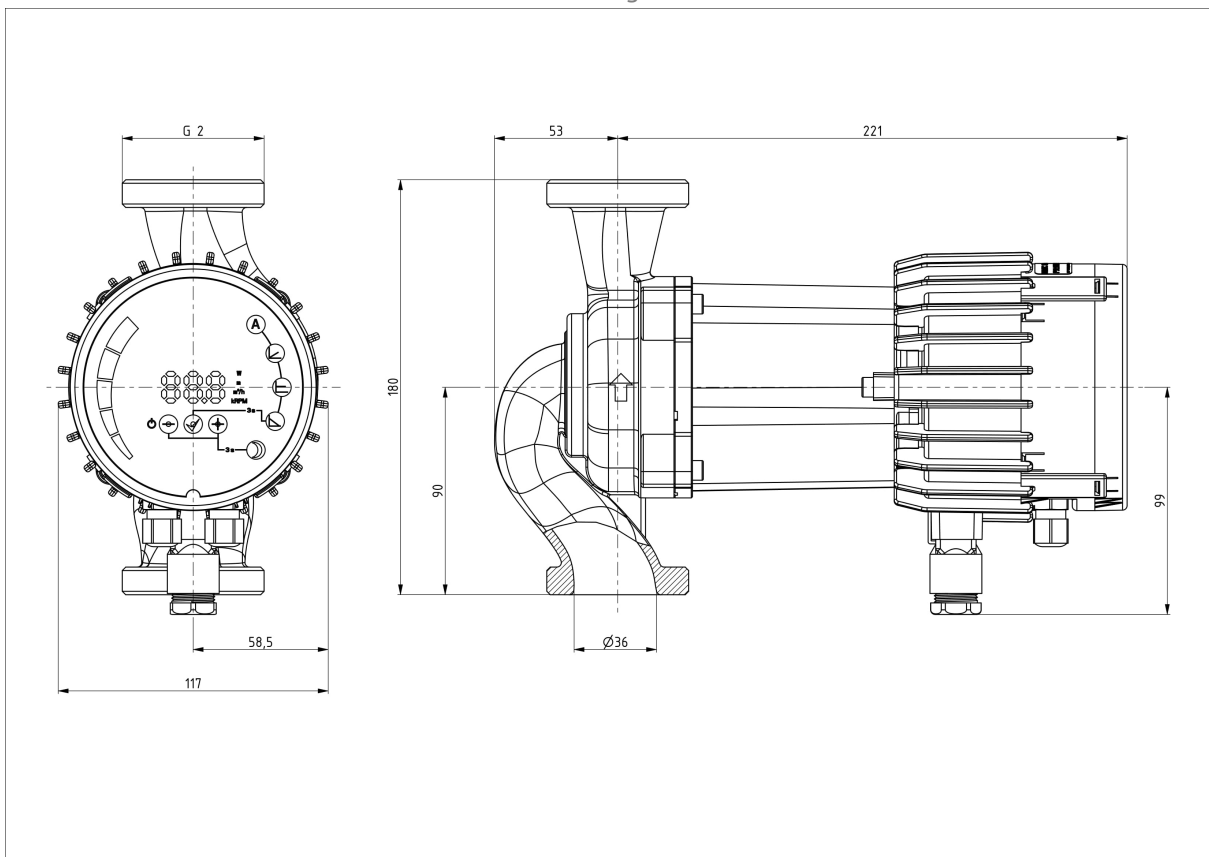



NMT SMART C 32/80-180

979527146

NMT SMART C / Electronically regulated circulating pump - communication

Electrical wiring

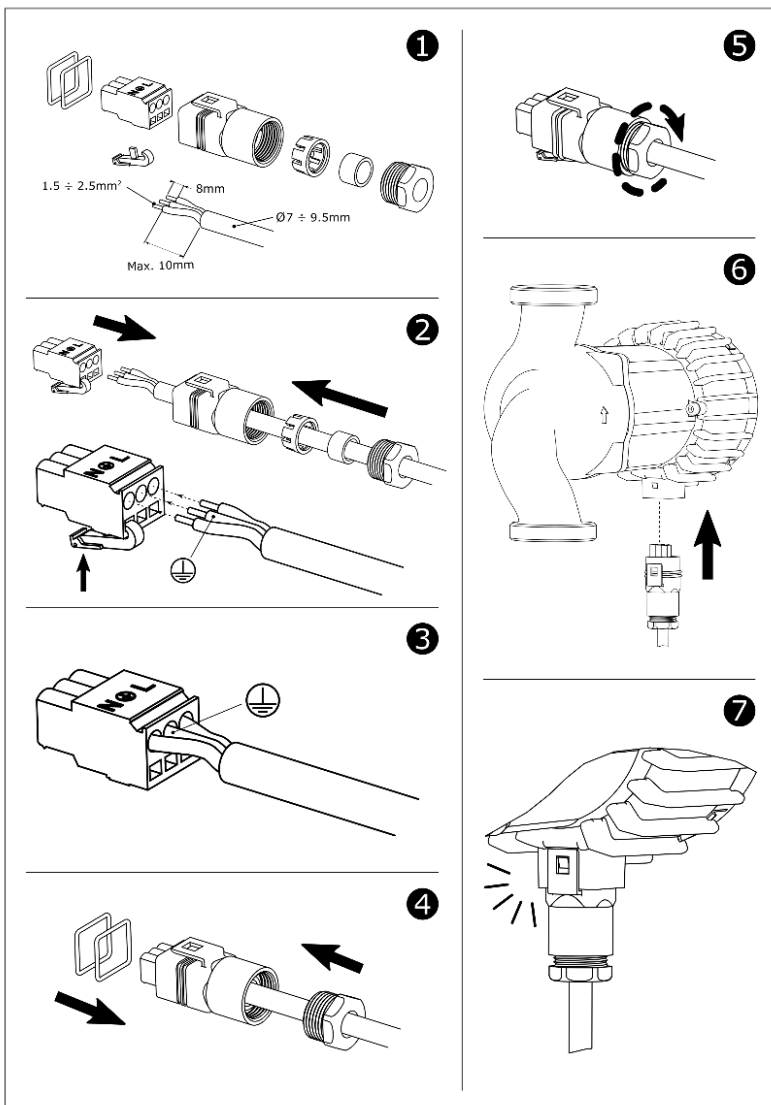



NMT SMART C 32/80-180

979527146

NMT SMART C / Electronically regulated circulating pump -
communication